

EXTRA VALUE TO YOUR INVESTMENT

INCREASED SAFETY

MAXIMUM FUNKTIONALITY

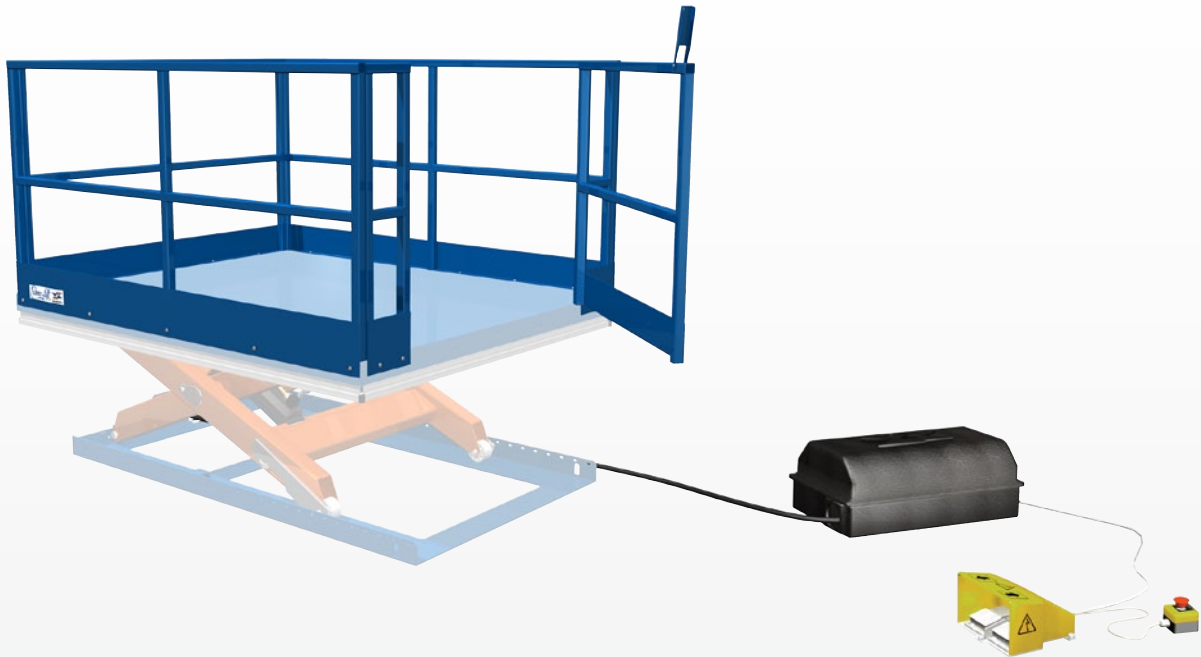

ACCESSORIES FOR EXTENDED FUNCTIONALITY

To EdmoLift's products a variety of accessories is available which add extra value to your investment. In this brochure there are illustrations of the most common accessories that we can equip our products with.

There are some important issues that should be considered in the selection and placement of accessory and the environment of the lift table.

- ⦿ Will there be someone travelling on the lift table?
- ⦿ Will the table be installed in a pit?
- ⦿ Will the platform be run over in closed height?
- ⦿ Will the lift table be installed outdoors or indoors?
- ⦿ Will the lift table be used very intensively?
- ⦿ Will additional security features be required around the lifting table?
- ⦿ Will the lift table need to be moved?
- ⦿ Will the load on the platform need to rotate?
- ⦿ How is the load weight distributed over the platform?
- ⦿ Height of load and center of gravity?

HD-EXECUTION OF THE TABLE IN INTENSIVE USE

Lift tables are of standard design fitted for good and prolonged function in "normal" operation. In intensive driving with heavy loads, fast speed, tough environment, and perhaps more shifts requires that the table sometimes is oversized and HD-equipped.

HD-execution should be used when the number of lift cycles exceed 10.000/year or if the lift cycles is more than 10/hour. The execution comes with ball-bearing wheels, machined shafts, grease nipples in all leads and drainage of the cylinders to the tank.

REQUEST FOR QUOTE!

- ⦿ Central lubrication
- ⦿ Explosion proof
- ⦿ Other color
- ⦿ ESD-execution
- ⦿ Galvanization
- ⦿ Stainless execution
- ⦿ HD-execution

LIFT TABLE ACCESSORIES

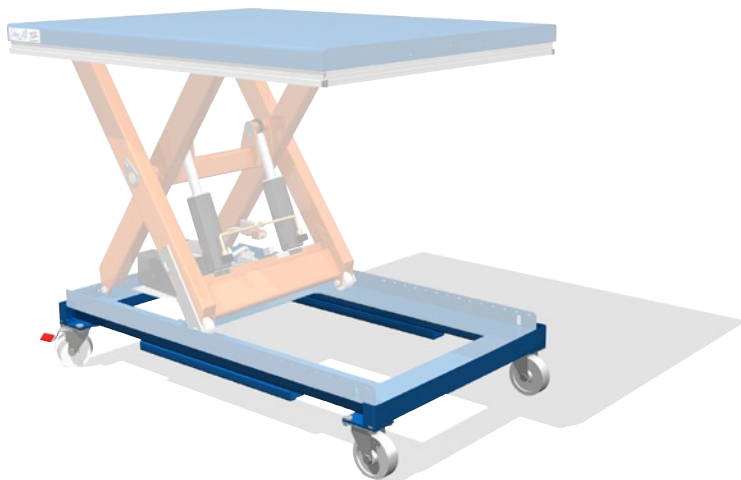

Wheel chassis

Provided with wheels the lift platform becomes a mobile. The trolley frame consists of two swivel braked caster wheels and two fixed wheels.

Truck handling chassis

Enables the lift table to be easily transported with a forklift or hand pallet truck.

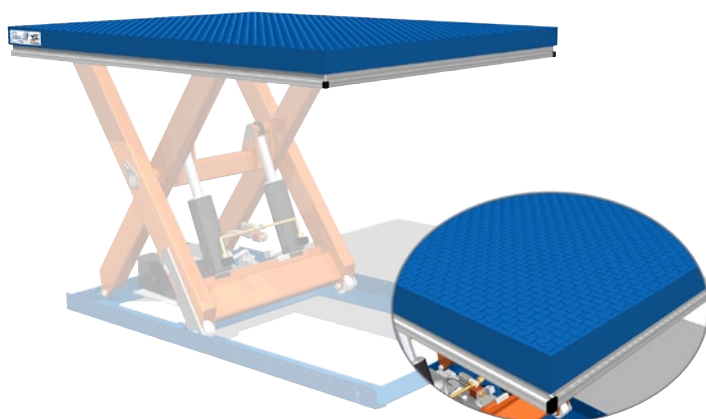
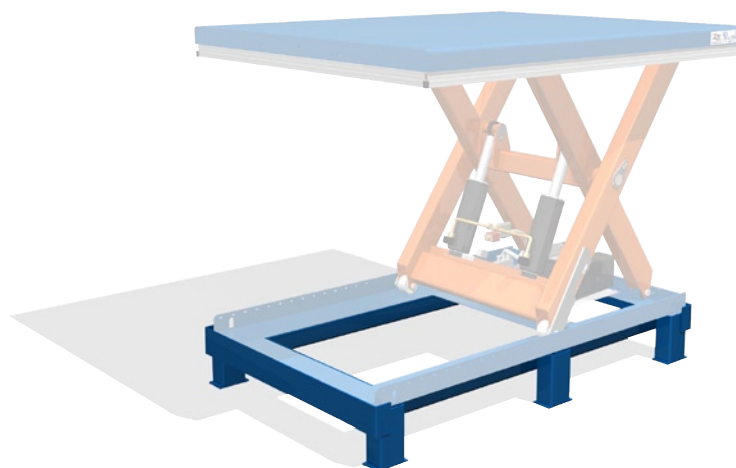

Tear plate platform

The tear plate platform minimizes the risk for cargo to slip from the table surface.

The tear plate platforms are recommended for tables located outdoors.

LIFT TABLE ACCESSORIES

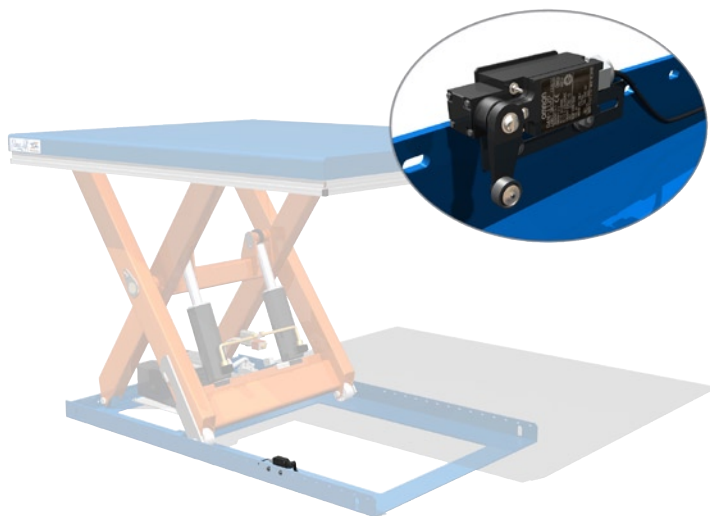

Limit switch

Stops lift at pre-set height, fully adjustable.

Loadflap manual

For bridging the gap between the lift table and loading dock or vehicle. Manually operated. This option is mainly used on lorry loaders.

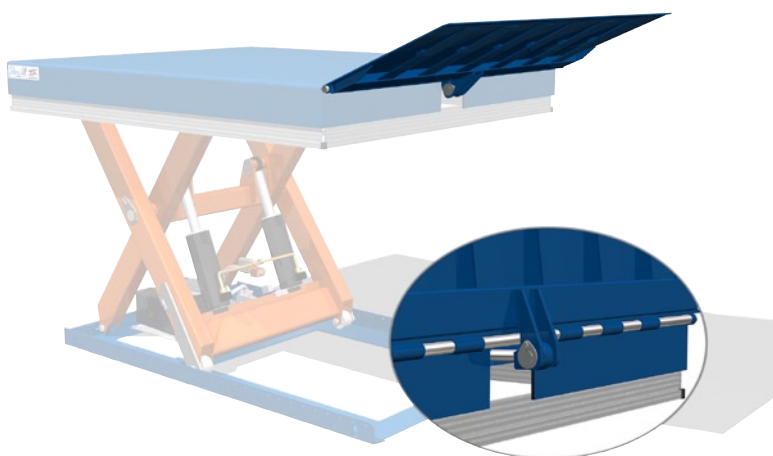
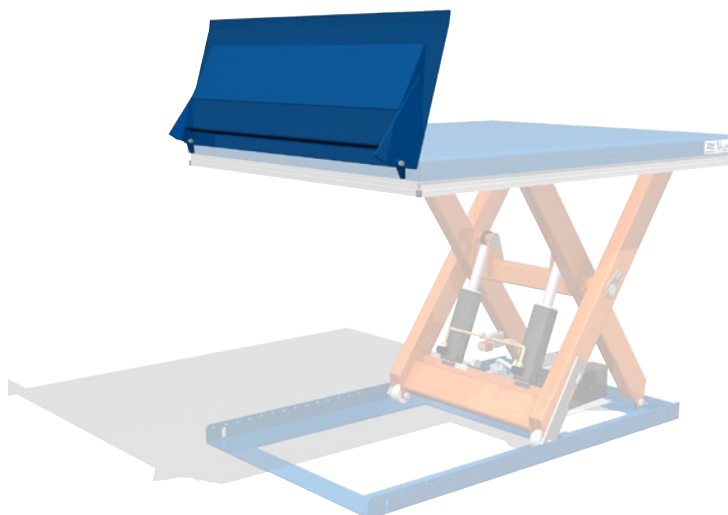

Loadflap hydraulic

For bridging the gap between the lift table and loading dock or vehicle. Hydraulic operated. This option is mainly used on lorry loaders.

LIFT TABLE ACCESSORIES

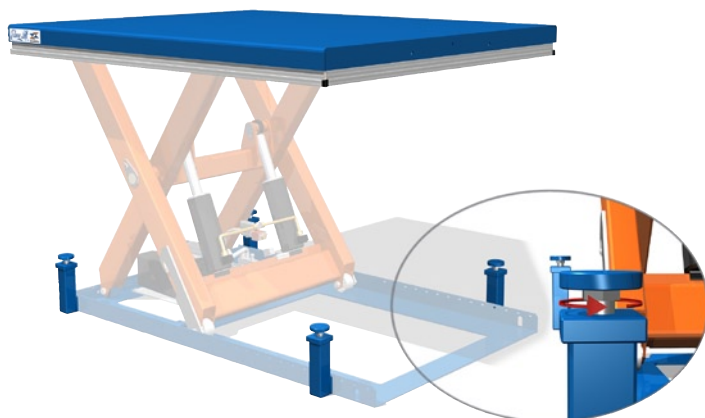

Mechanical Stops

For installations where the platform is flush with the floor or ground in the raised position, the table can be equipped with heavy-duty bolts capable of withstanding severe loading.

Guard Rail

A 1100 mm high rail with a mid-rail and a 150 mm high toe kick-plate is a recommended option when the lift table is used by persons or as a goods lift between levels.

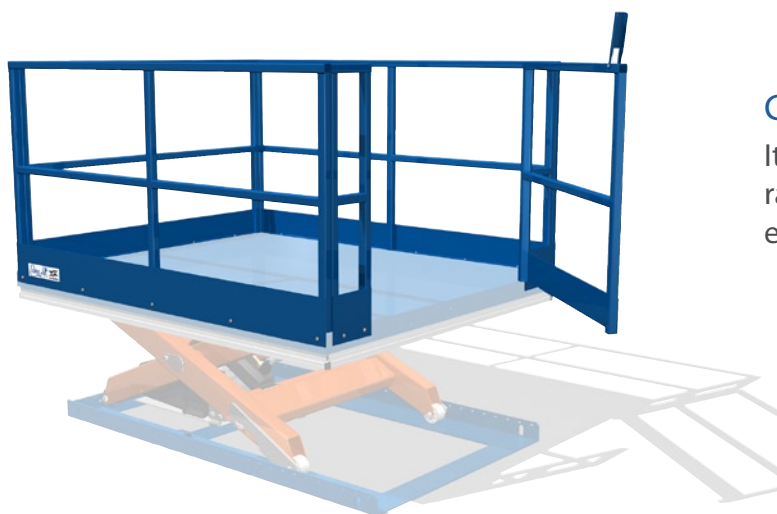
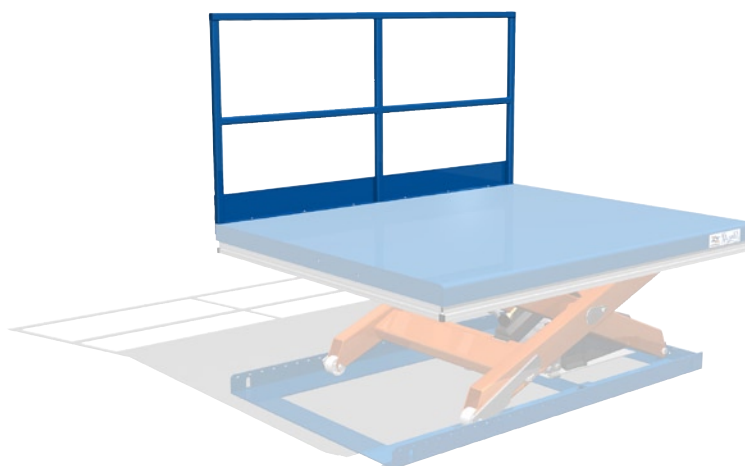

Guard Rail With Gate

It is usually combined with the barrier rails and can be supplied with either electrical or mechanical locking or both.

LIFT TABLE ACCESSORIES

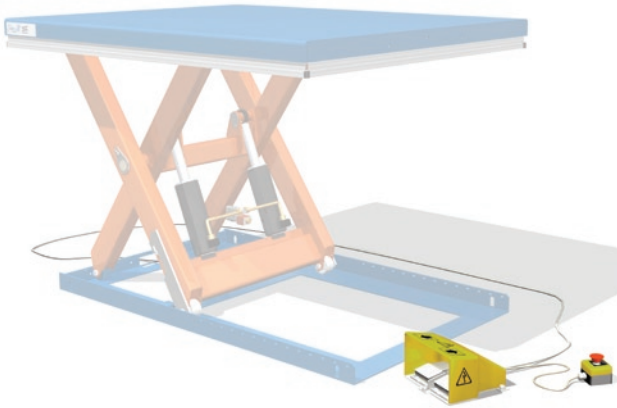

Foot Control Unit

A very good solution when you must have both hands free.

External Powerpack In Plastic Cover

Fully protected, a remote power pack makes access for servicing easy.

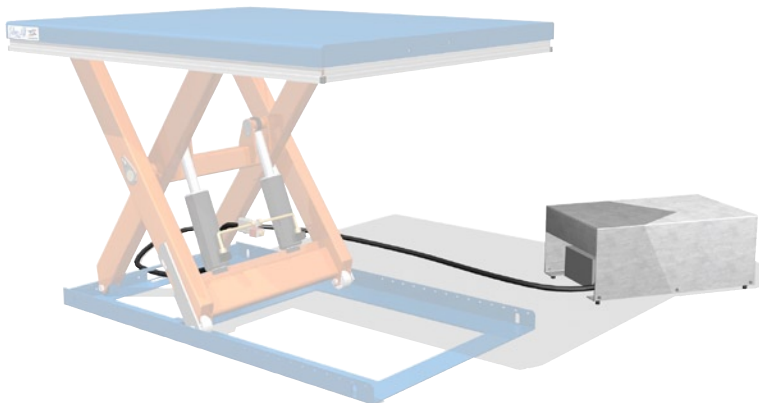
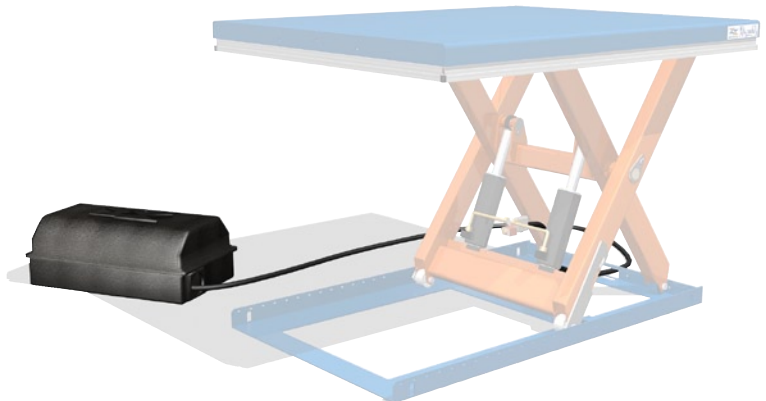

External Power Pack With Steel Cover

Provides extra protection in exposed environments. Also provides protection if there is a risk for falling objects hitting the power pack.

LIFT TABLE ACCESSORIES

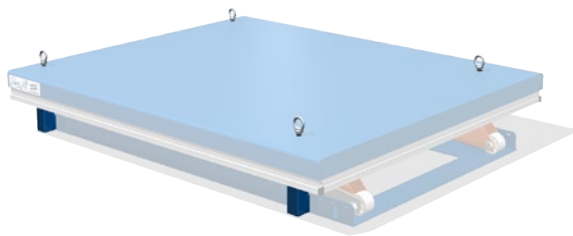

Lifting Eyebolts

Makes installation, transportation easier and safer.

* Some units require a larger platform.

Turntable circular

Recessed or integrated in the lift table top.

Turntable recessed into a secondary table top, fitted to the main scissor lift platform.

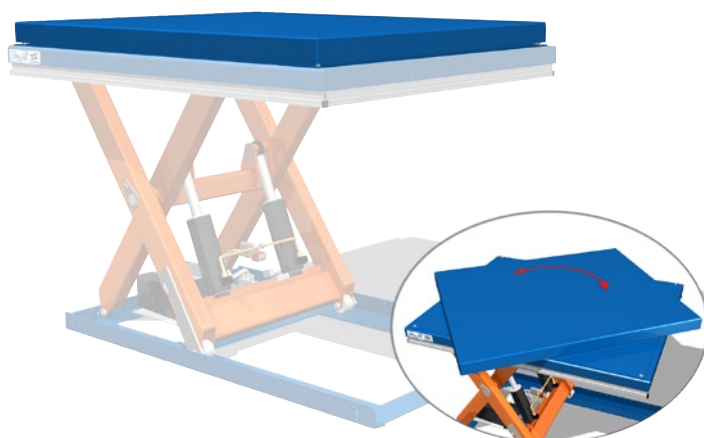
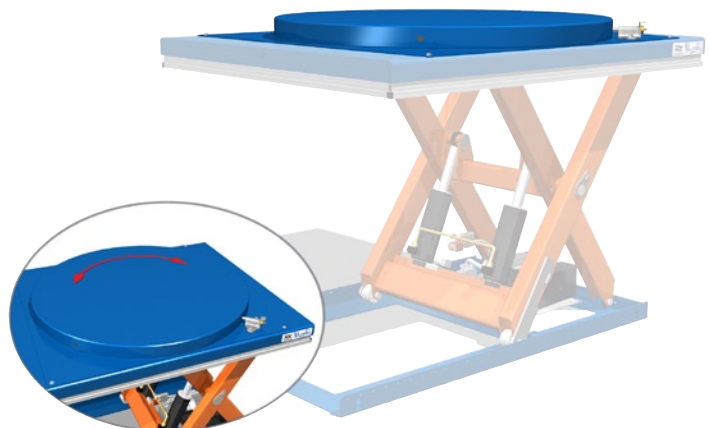

Turntable Rectangular

Fitted on the lift table top and includes an inductive sensor to avoid trapping risks.

Rectangular surface bolted to the main scissor lift platform. The unit has safety spacing and is electro-interlocked to the lift travel to reduce the risk of trapping an operator.

LIFT TABLE ACCESSORIES

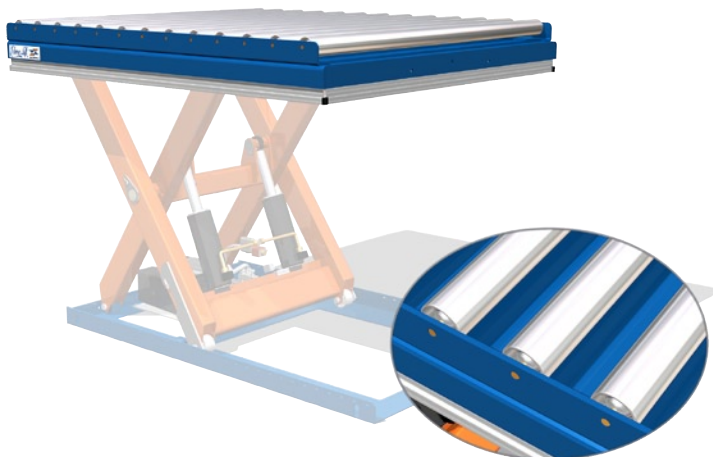

Roller Conveyor

Roller conveyor or another conveyor type is often utilised in production systems where different levels need to be reached.

*Always state the goods length and weight for the best solution.

Ramp Shortside

Free standing, smooth surface.
Ensure gradient is suitable for your load.

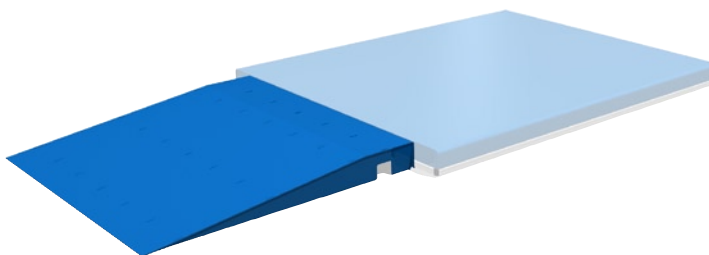

Ramp Longside

Free standing, smooth surface.
Ensure gradient is suitable for your load.

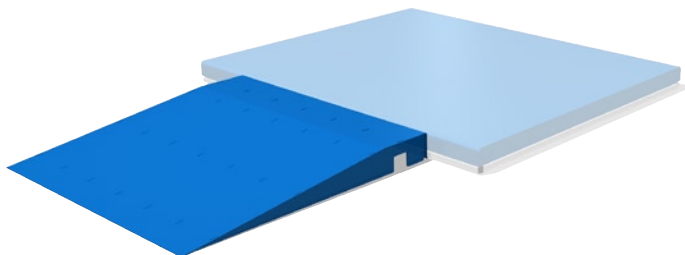

LIFT TABLE ACCESSORIES

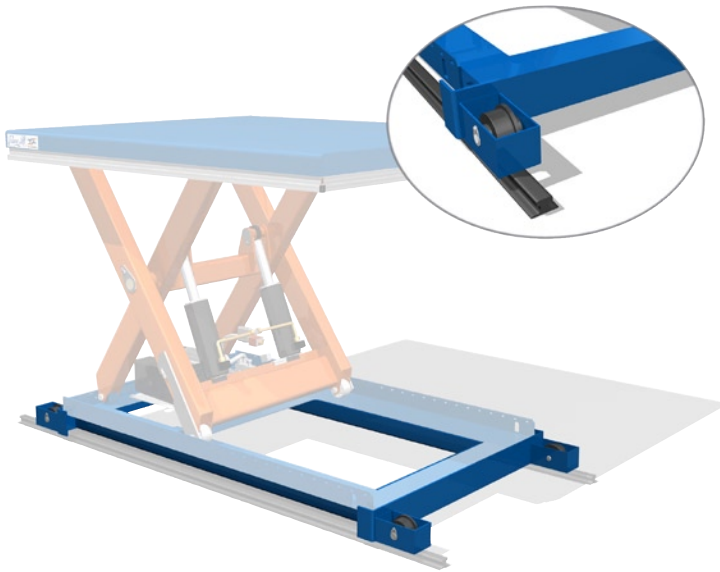

Rail Running Chassis

Level differences in a track bound transportation system can be simply eliminated by utilising a flange wheel base frame. This equipment can be supplied with or without powered drive unit.

The easiest way to cope with a difference in level in a track bound transportation system is to equip a lifting table with flanged wheels. The base can be an unpowered bogie or can be fitted with a drive unit for self-propulsion.

Reinforced Platform

Gives additional support to the table. Also includes mechanical stops in baseframe.

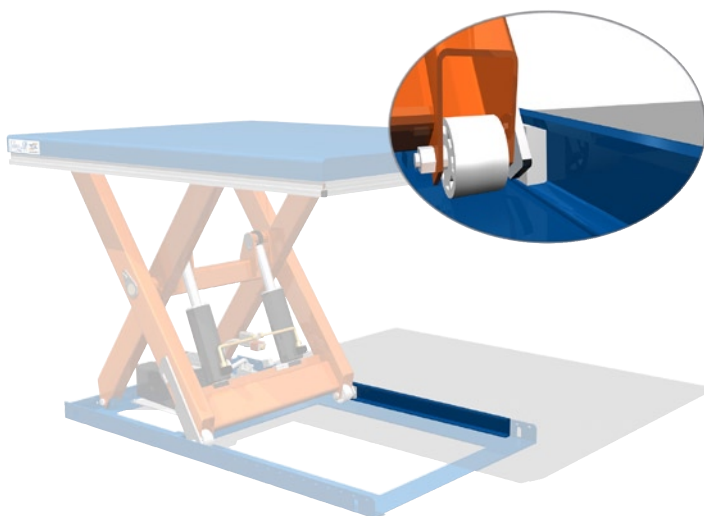
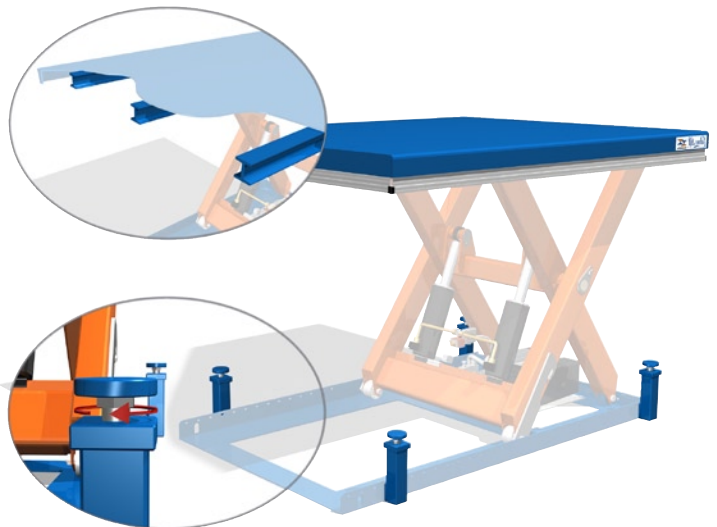

Tipping Protection

Helps to stabilize the lift table. Minimizes the risk for the lift table to hinge upward.

* Is recommended if the platform extension is over 10 %.

LIFT TABLE ACCESSORIES

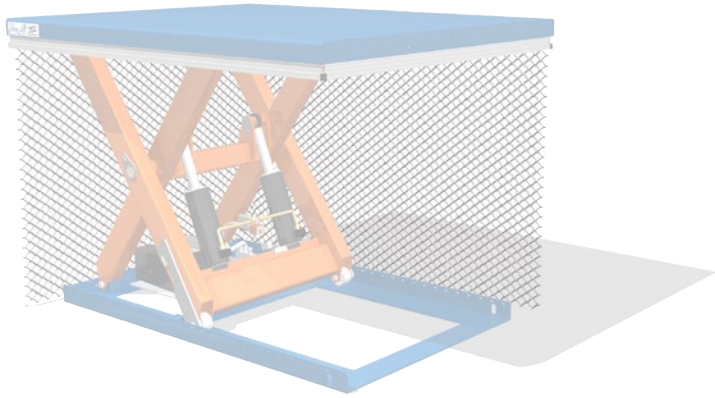

Protective Wire Mesh

Protects the table from dust, dirt and debris in exposed environments.

The lift table can be enclosed in a chain mesh curtain to reduce the risk of injury or entrapment. The chain mesh curtain is also a useful protection against mechanical damage.

* All protective mesh/skirts requires a table extension +150 mm LxB.

Protective Bellow

The bellows are suitable for weather proofing the equipment in an outdoor environment.

* All protective mesh/skirts requires a table extension +150 mm LxB.

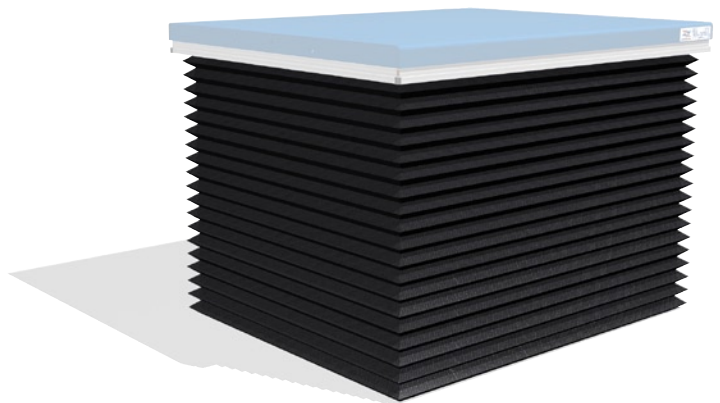

Protective Skirt

The skirt are suitable for weather proofing the equipment in an outdoor environment.

*All protective mesh/skirts requires a table extension +150 mm LxB

LIFT TABLE ACCESSORIES



Inspection Hatch

Provides access to the powerpack when the lift table is fully closed.

Heavy Duty Execution

Fitted with additional features for tables intended for intensive operation.

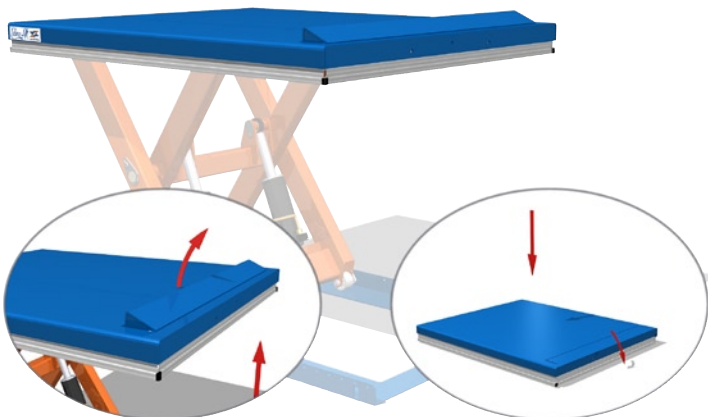
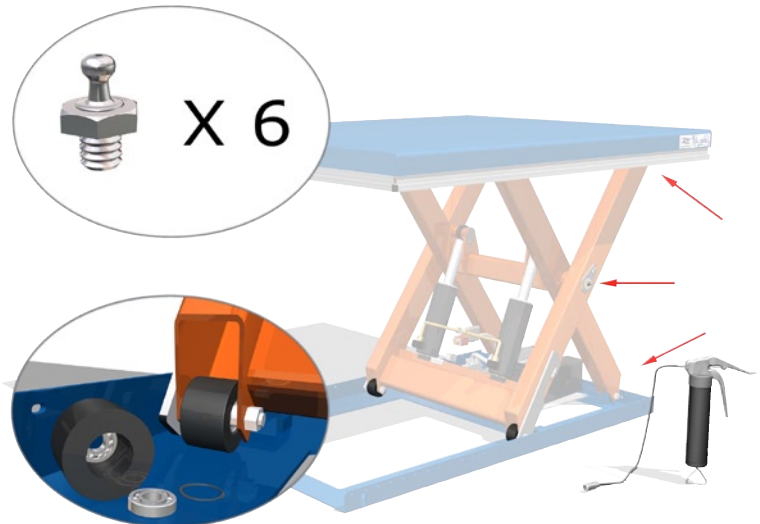

Auto Raising Stop

Designed to prevent accidental roll off from the platform when the table starts to elevate.

*Demands extension of the platform length +150mm

LIFT TABLE ACCESSORIES

Chequered Aluminium Platform

Non slip, non rust surface.

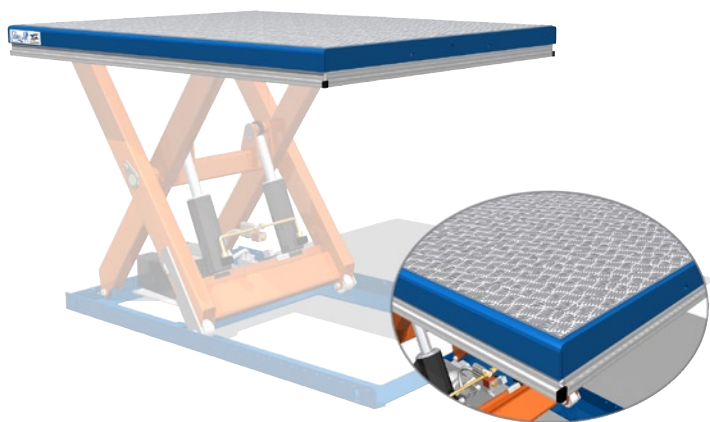

Mechanical locks in platform

Secure a platform that can be lowered below floor level. When the platform is secured to the ground it can take heavy loads and even be run over by other vehicles.

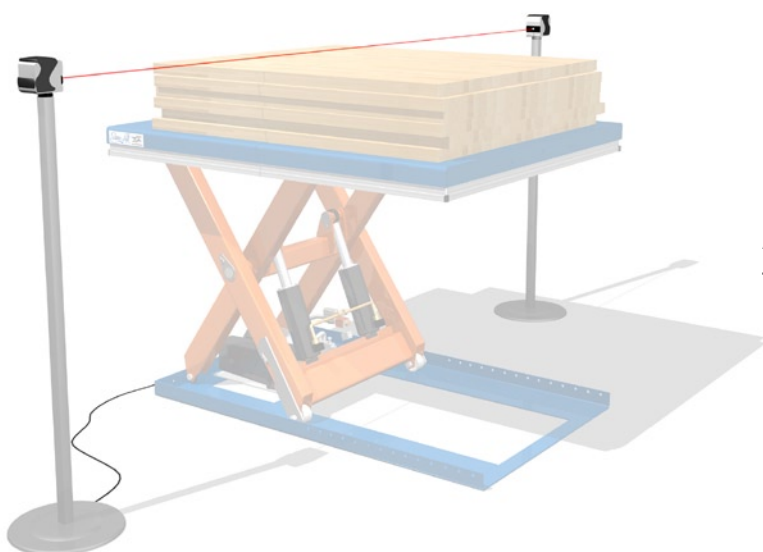
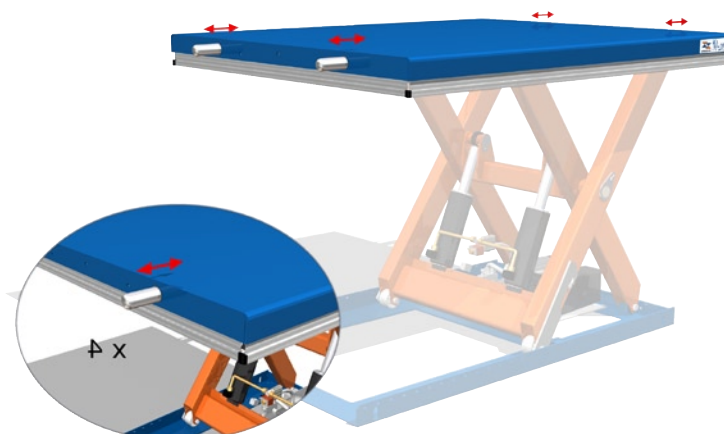

Fotocells

Automatic lifting and lowering of the lift table.

LIFT TABLE ACCESSORIES

Packaging

In a rigid and durable wooden casing, in order to allow multiple handling and a safe arrival of the goods.

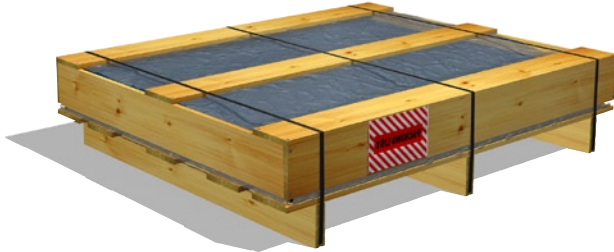

Our product packaging is also available in a "classified version" in compliance with ISPM 15.

WHEN ADDITIONAL EQUIPMENT IS INSTALLED, WE DESCRIBE THE LOCATION AS FOLLOWING SKETCHES.

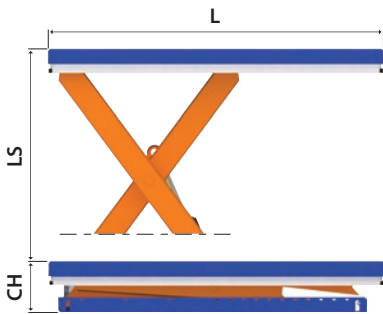

LS = Lift stroke, CH = Closed height



L = Length, W = Width

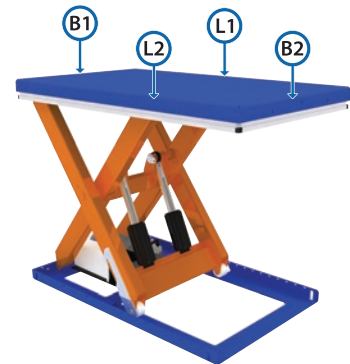

B1 = Fixed side, B2 = Wheel side

PIT DRAWING FOR LIFT TABLES

Upon installation of a lift table in a pit, the pit should be constructed as shown to the right.

W = Width of pit = Platform width + 30mm

L = Length of pit = Platform length + 30mm

H = Depth of pit = Platform closed height + 5mm

Pit material bearing capacity must at least meet classification C12/15 concrete.

Tables placed in an outside environment shall be equipped with a external powerpack if possible or be protected/covered.

The pit drawing is not designed for low profile tables or when the product is equipped with certain accessories.

Fixed side of the lift table (B1)

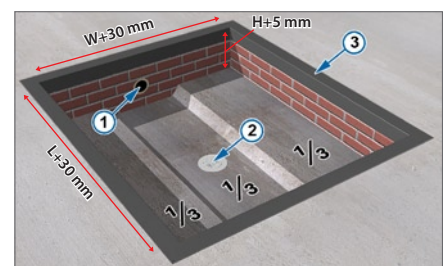
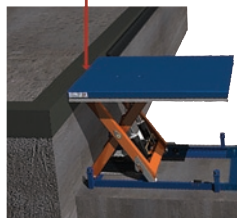

- ① Tubes for incoming connections (min. 100mm) Fixed side of table is placed against this edge.
- ② Drainhole, the third in the middle of the pit should be 80mm lower than H.
- ③ L-profile of 100x100mm reinforcing the pit edges.

